

Altimeter Product Manual

**Covering PA200, PA500, LRPA
and Dual Frequency Echosounder**

0286-SOM-00001, Issue: 10



© Trittech International Ltd

The copyright in this document is the property of Trittech International Ltd. The document is supplied by Trittech International Ltd on the understanding that it may not be copied, used, or disclosed to others except as authorised in writing by Trittech International Ltd.

Trittech International Ltd reserves the right to change, modify and update designs and specifications as part of their ongoing product development programme.

All product names are trademarks of their respective companies.



Table of Contents

Help & Support	4
Warning Symbols	5
1. Specification	6
1.1. Notes on Specifications	6
1.2. Dimensions	6
1.3. PA200/PA500 Electrical & Acoustic	10
1.4. PA200/PA500 Physical & Environmental	11
1.5. LRPA Electrical & Acoustic	11
1.6. LRPA Physical & Environmental	12
1.7. Dual Frequency Echosounder Electrical & Acoustic	12
1.8. Dual Frequency Echosounder Physical & Environmental	13
2. Introduction	14
3. Installation	15
3.1. Optimal Orientation	15
3.2. Mounting Material and Suitable Brackets	15
3.3. Dual Frequency Altimeter	15
3.3.1. Orientation	15
3.3.2. AHRS Sensor Axes	16
3.3.3. Mounting	16
3.4. Long Term Use	17
3.5. Standard Pin-Out Diagrams	17
3.6. Example Test Cables	20
4. Operation	22
4.1. General Guidelines	22
4.2. Dual Frequency Echosounder	24
4.2.1. Echosounder Output	24
4.2.2. AHRS Output	24
4.3. Seagnet Pro & SeaKing or Super SeaPrince DST AUX Port	25
4.4. Using with SeaKing 700 Series (Bathy)	29
4.5. AltTest Software	29
5. Maintenance	34
5.1. General Guidelines	34
5.2. Ordering Parts	35
5.3. Disassembly of the Altimeter	36
6. Configuration	37
6.1. Non-configurable Parts	37
6.2. Dip Switch Settings	37
A. Jumper Settings for SeaKing with Altimeter on AUX Port	40
B. Addressable Altimeter	44
Glossary	46

Help & Support

First please read this manual thoroughly (particularly the Troubleshooting section, if present). If a warranty is applicable, further details can be found in the Warranty Statement, 0080-STF-00139, available upon request.

Tritech International Ltd can be contacted as follows:

	Mail	<i>Tritech International Ltd</i> Peregrine Road Westhill Business Park Westhill, Aberdeenshire AB32 6JL, UK
	Telephone	+44(0)1224 744 111
	Email	support@tritech.co.uk
	Website	www.tritech.co.uk

Prior to contacting *Tritech International Ltd* please ensure that the following is available:

1. The Serial Numbers of the product and any *Tritech International Ltd* equipment connected directly or indirectly to it
2. Software or firmware revision numbers
3. A clear fault description
4. Details of any remedial action implemented



Contamination

If the product has been used in a contaminated or hazardous environment you *must* de-contaminate the product and report any hazards *prior* to returning the unit for repair. *Under no circumstances should a product be returned that is contaminated with radioactive material.*

The name of the organisation which purchased the system is held on record at *Tritech International Ltd* and details of new software or hardware packages will be announced at regular intervals. This manual may not detail every aspect of operation and for the latest revision of the manual please refer to www.tritech.co.uk

Tritech International Ltd can only undertake to provide software support of systems loaded with the software in accordance with the instructions given in this manual. It is the customer's responsibility to ensure the compatibility of any other package they choose to use.

Warning Symbols

Throughout this manual the following symbols may be used where applicable to denote any particular hazards or areas which should be given special attention:



Note

This symbol highlights anything which would be of particular interest to the reader or provides extra information outside of the current topic.



Important

When this is shown there is potential to cause harm to the device due to static discharge. The components should not be handled without appropriate protection to prevent such a discharge occurring.



Caution

This highlights areas where extra care is needed to ensure that certain delicate components are not damaged.



Warning

DANGER OF INJURY TO SELF OR OTHERS

Where this symbol is present there is a serious risk of injury or loss of life. Care should be taken to follow the instructions correctly and also conduct a separate Risk Assessment prior to commencing work.

1. Specification

1.1. Notes on Specifications

The specifications outlined below are for standard altimeters fitted with *Tritech International Ltd* 6-pin connectors and are the most common variant of altimeter supplied by *Tritech International Ltd*. There are a large variety of options available in terms of connectors and it is outwith the scope of this manual to cover every configuration possible.

Other connectors that have been supplied include:

- Burton Seaconn 1508
- Branter SeaCon XSG-4/XSG-5
- Subconn:
 - BH4-F
 - BH6-M
 - BH8-M
 - IL6-FS
 - MCBH4-M SS
 - MCBH5-M
 - MCBH6-F

For each of the above a variety of wiring schemes has been used and so it will be necessary to contact *Tritech International Ltd* for a detailed description of the product supplied (provided serial numbers are available). Additionally, the list is not exhaustive and there may be special items or other connectors that are not included.

1.2. Dimensions



Note

Tritech International Ltd reserve the right to change, modify and update designs and specifications as part of their ongoing product development program.

PA200/PA500 Straight Delrin, Aluminium & Stainless Steel

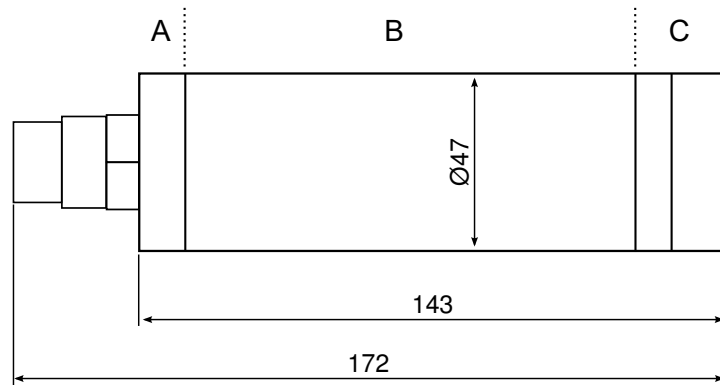

Not to scale, dimensions in mm.



Note

The standard *Tritech International Ltd* 6-pin connector is rated to a maximum depth of 4000m, so any deep rated altimeters (up to 6800m) will be fitted with different connectors, the Burton 5506 shown here is a representation only.

PA200/PA500 Straight Stainless Steel

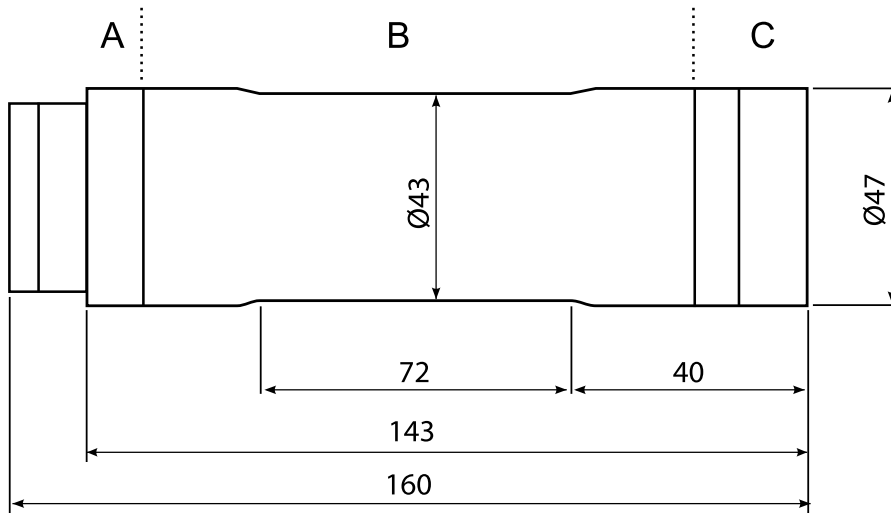

Not to scale, dimensions in mm.

PA200/PA500 Right Angle Delrin, Aluminium & Stainless Steel

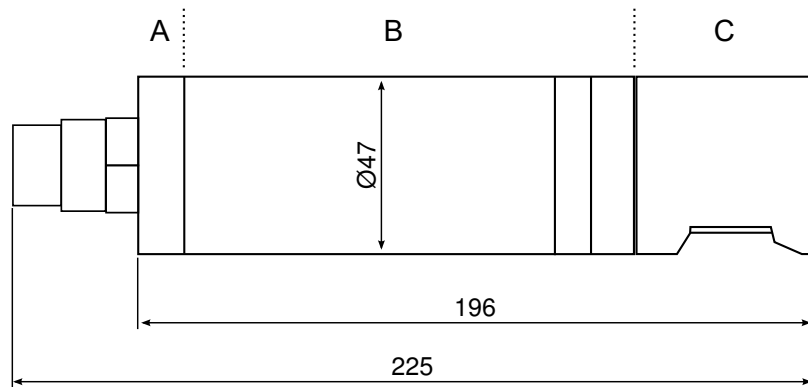

Not to scale, dimensions in mm.



Note

The transducer endcap (part C in the image) is made out of ABS regardless of the body material.



Note

The standard *Tritech International Ltd* 6-pin connector is rated to a maximum depth of 4000m, so any deep rated altimeters (up to 6800m) will be fitted with different connectors, the Burton 5506 shown here is a representation only.

PA200/PA500 Right Angle Stainless Steel

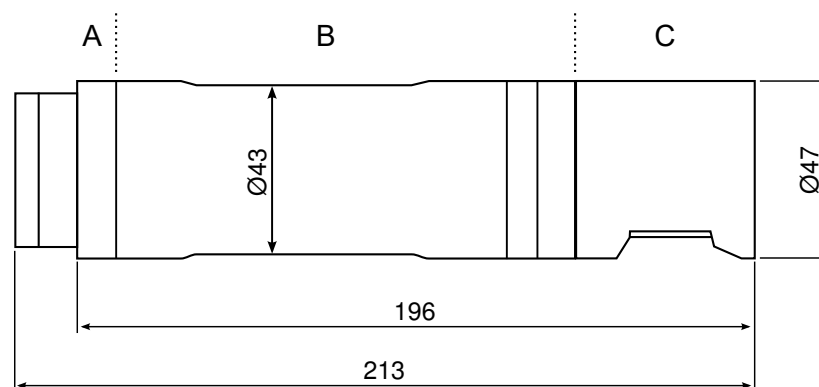

Not to scale, dimensions in mm.



Note

The transducer endcap (part C in the image) is made out of ABS regardless of the body material.

LRPA 4000m

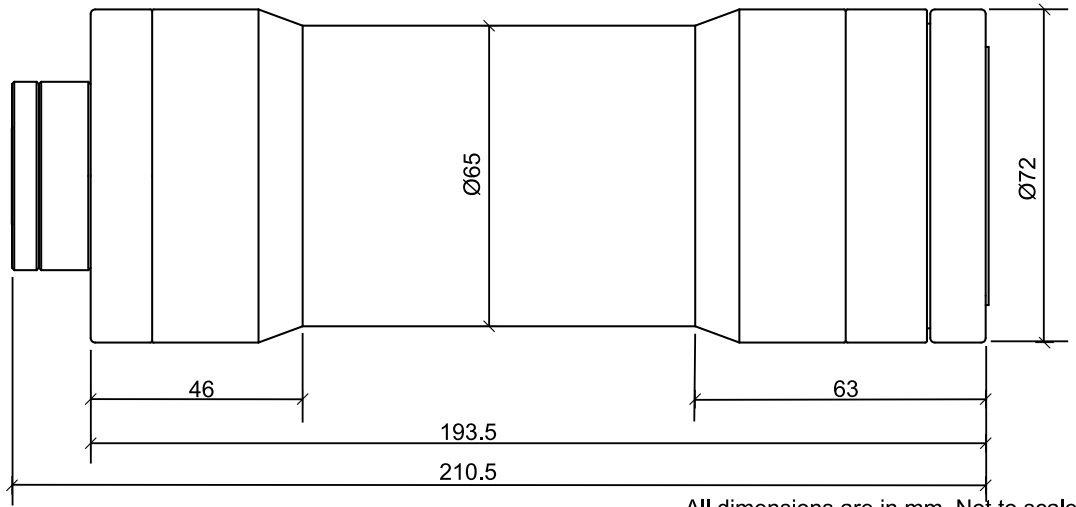

All dimensions are in mm. Not to scale.

LRPA 6000m



All dimensions are in mm. Not to scale.



Note

The 6000m rated units have a Subconn MCBH6F-SS series connector as standard but other connectors are also used.

Dual Frequency Echosounder

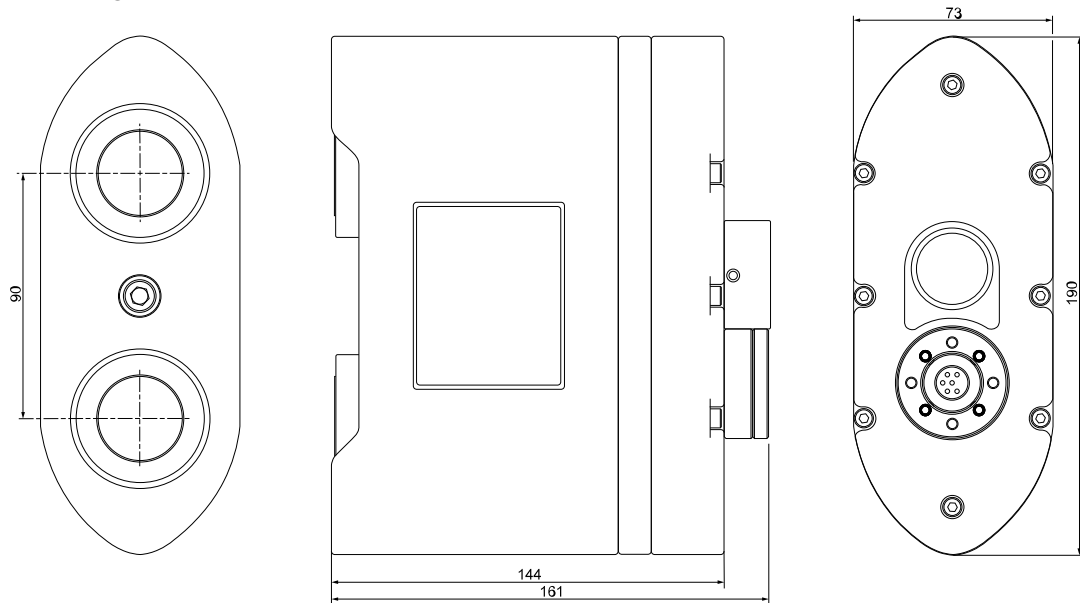

All dimensions are in mm. Not to scale

1.3. PA200/PA500 Electrical & Acoustic

	Acoustic	
	PA200	PA500
Operating frequency	200 kHz	500 kHz
Beamwidth	20° conical	6° conical
Peak Source	187 dB re 1 μ Pa @ 1 m	197 dB re 1 μ Pa @ 1 m
Pulse Length	300 μ s	100 μ s
Range	1 to 100 m (0.7 to 50 m optional)	0.3 to 50 m (0.1 to 10 m optional)
Digital resolution	1 mm	
Analogue resolution	0.025% of range	

Electrical and Communication	
Power supply (Factory Set)	10.5 V DC to 18 V DC (160 mA at 12 V DC) 18 V DC to 28 V DC (80 mA at 24 V DC)
Analogue output	0 to 10 V DC (with 24 V power supply) 0 to 5 V DC or 4 to 20 mA
Data communications	RS232 or RS485
Output modes	Free running, interrogated or part of multidrop network



Note

For current loop output of 4-20mA the power supply must be at least 15V DC.

1.4. PA200/PA500 Physical & Environmental

Physical					
Materials	Delrin™ S02133/ S02135	Aluminium S05303/ S04678	Aluminium R/A S04807/ S03447	Stainless Steel S02125/ S02127	Titanium Grade 6Al-4V
Weights	0.42 kg in air, 0.15 kg in water	0.57 kg in air, 0.3 kg in water	0.67 kg in air, 0.29 kg in water	1.15 kg in air, 0.8 kg in water	See <i>Tritech for information</i>
Depth rating	700 m with Delrin™ housing (aluminium alloy endcap)	4000 m All right-angle transducers are ABS (part C in the diagrams)		4000 m standard (6800m available)	6800 m
Operating temperature	-10 to 35 °C				
Storage temperature	-20 to 50 °C				

1.5. LRPA Electrical & Acoustic

Acoustic	
Operating frequency	200 kHz
Beamwidth	10° conical
Range	2 to 200 m
Digital timing resolution	1 mm
Analogue resolution	0.025% of range

Electrical and Communication	
Power supply	10.5 V DC to 18 V DC (180 mA at 12 V DC) 18 V DC to 28 V DC (90 mA at 24 V DC)
Analogue output	0 to 10 V DC (with 24 V power supply) 0 to 5 V DC or 4 to 20 mA
Communication protocols	RS232 or RS485
Output modes	Free running, interrogated or part of multidrop network



Note

For current loop output of 4-20mA the power supply must be at least 15V DC.

1.6. LRPA Physical & Environmental

	Physical	
	Standard model	Deep rated model
Weight in air	1.3 kg	4.33 kg
Weight in water	0.95 kg	2.93 kg
Depth rating	4000 m	6000 m
Materials	Aluminium alloy housing Stainless Steel housing	Stainless Steel housing
Operating temperature	-10 to 35 °C	
Storage temperature	-20 to 50 °C	

1.7. Dual Frequency Echosounder Electrical & Acoustic

Acoustic (Altimeter)		
Operating frequency	200kHz	500kHz
Beamwidth	Refer to Section 1.3, "PA200/PA500 Electrical & Acoustic"	
Peak Source		
Pulse Length		
Range		
Digital timing resolution		

AHRS-1 (Accuracy)	
Roll/Pitch (static)	0.5°
Roll/Pitch (dynamic)	0.8° RMS
Yaw (dynamic)	2° RMS

Electrical and Communication		
	Altimeter	AHRS
Power supply	10.5-21 VDC or 21-28 VDC (internally set)	
Analogue output	None (Pin 5 used for AHRS RS232 output in free-running mode)	
Communication protocols	RS232 or RS485	
Serial output format	Yxx.xxxm only (where Y is the LAN interrogation character)	\$HCHDM \$EHDT \$PASHR \$PHTRH \$PHTRO \$PHDID TSS1 TSS2
Topside control	Serial interrogate only	Free running (Pin 5 only) or Interrogate (Pins 1 + 2)
Max interrogation rate	Altimeter = 8Hz Altimeter + AHRS = 4Hz	

1.8. Dual Frequency Echosounder Physical & Environmental

Physical	
Weight in air	3.4 kg
Weight in water	1.7 kg
Depth rating	100 m
Materials	Aluminium alloy housing Acetal sleeve
Operating temperature	-10 to 35 °C
Storage temperature	-20 to 50 °C

2. Introduction

The PA200, PA500,LRPA and Dual Frequency Echosounder are sonar ranging devices which when mounted vertically give the height above the sea bed or in any other orientation provides a method for measuring subsea distances. The PA200, PA500 and LRPA can be configured to operate on their own or under control from an external unit.

The altimeters incorporate a fixed crystal transducer which is matched to the range and resolution required. The altimeter data output signals can be transmitted as both digital and analogue signals and can communicate using RS232 or RS485 protocols.

The dual Frequency Echosounder combines the current PA200 and PA500 whilst incorporating an X-Sens MTi-3 AHRS pitch and roll sensor.

This manual covers the generic aspects of altimeters and shows the specifications for the standard setup with the *Tritech International Ltd* 6 pin connector. There are a wide range of different configurations available for Tritech altimeters so it is important to use this manual in conjunction with the original purchase order which should detail the exact configuration of the product in hand.

If the details from the original order are not available please try contacting *Tritech International Ltd* to retrieve the information. It will be necessary to supply all the serial numbers off the altimeter body and/or label.

3. Installation

3.1. Optimal Orientation

For ROV installation always mount the altimeter so that it is as close to the true vertical as possible in relation to the trim position of the vehicle. The transducer head should be clear of any obstruction and away from possible sources of interference, such as the wake from thrusters or from electrical devices that may have high electromagnetic emissions. Errors in the head alignment can give rise to unreliable results.

3.2. Mounting Material and Suitable Brackets



Caution

Avoid any metal alloys containing copper such as brass or bronze.

Non-metallic clamps should always be used where possible to prolong the life of the unit and prevent any galvanic corrosion effects. If metallic clamps are used they should be electrically insulated from the sonar body by means of rubber or plastic strips or mount brackets of at least 3mm thickness and extending at least 3mm beyond the clamp boundary. They should also be painted or lacquered with at least three coatings.

3.3. Dual Frequency Altimeter

3.3.1. Orientation

The shape of the echosounder is designed with hydrodynamics in mind. The front of the echosounder is at the opposite side to the Trittech connector which is provided protection from water flow by the mounting bracket.

FRONT



3.3.2. AHRS Sensor Axes

The axes for the AHRS within the echosounder are shown below.

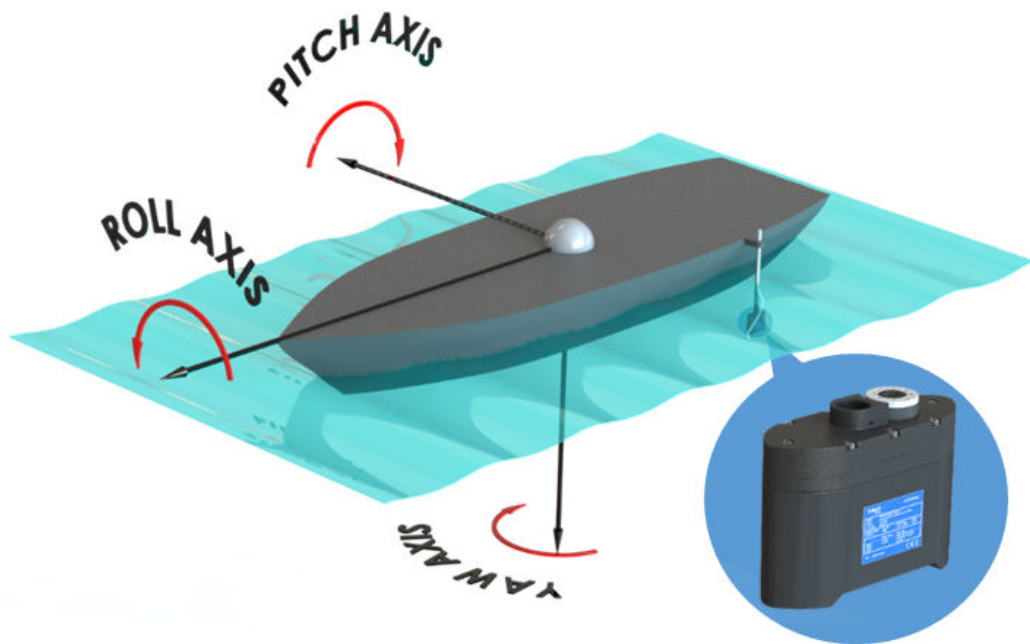

3.3.3. Mounting

The mounting point on the Dual Frequency Altimeter utilises as 1½"-14 BSW (Whitworth) thread. This interface is shared with the mounting system for the Tritech MicronNav and Gemini products.

Tritech adapters are listed below:



Items from left to right

Item No	Description	Qty
S11836	Gemini DB - Ø22mm Pole Assembly 0.5m	1
S11744	29mm ID x 40mm OD x 1mm Washer	1
S11743	Gemini DB - Pole Adapter Blank	1
S11904	Gemini DB - 1½"-18 UNEF Pole Adapter	1
S11741	Gemini DB - Reach & Rescue Pole Adapter	1

Common Interface thread: 1½"-14 BSW (Whitworth)

S11836: Utilises coupling on Ø22mm carbon pole as per USBL system

S11904: Supplied for US customers

S11743: A blank adapter for customer adaption

S11741: Configured to accommodate "sprung" pin engagement common to a range of 'Reach & Rescue' telescopic pole systems

S11836 & S11744 are supplied with all deployment pole mount brackets

3.4. Long Term Use



Caution

The stainless steel altimeters are not designed for long-term submersion and may suffer from corrosion if left underwater or in a splash zone for extended periods. Refer to the maintenance section for appropriate care.

3.5. Standard Pin-Out Diagrams



Caution

The power should be turned off before making a connection between the sonar head and surface controller (SCU or SeaHub).

The altimeter can operate in RS232 serial mode, RS485 serial mode, in analogue mode and as a current loop device. Analogue and serial modes can run on the same device with the analogue output signal on Pin 5. The pin out configurations are shown below for each type. Note that the different types require different communications boards so it is not generally possible to change from one type to another without returning the unit to Trittech.

RS232 Configuration

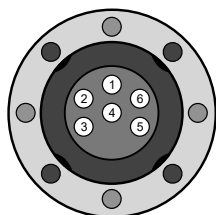

Trittech Waterblock

Pin	Function	Wire colour
1	RS232 Tx	Yellow
2	RS232 Rx	Blue
3	+V DC	Red
4	0V, RS232 Ground, Analogue Ground	Black
5	Analogue Output (optional)	Green
6	Chassis Ground	cable screen

RS485 Configuration

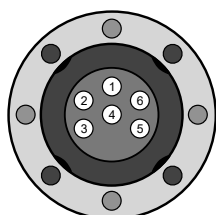

Trittech Waterblock

Pin	Function	Wire colour
1	RS485 A	Yellow
2	RS485 B	Blue
3	+V DC	Red
4	0V, Analogue Ground	Black
5	Analogue Output (optional)	Green
6	Chassis Ground	cable screen

Current Loop Configuration

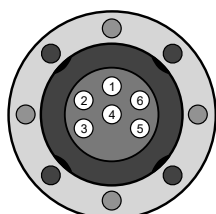

Trittech Waterblock

Pin	Function	Wire colour
1	+ Current Loop	Yellow
2	- Current Loop	Blue
3	+V DC	Red
4	0V, Analogue Ground	Black
5	Analogue Output (optional)	Green
6	Chassis Ground	cable screen

Analogue Only Configuration

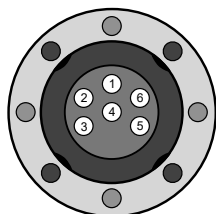

Tritech Waterblock

Pin	Function	Wire colour
1	(not used)	Yellow
2	(not used)	Blue
3	+V DC	Red
4	0V, Analogue Ground	Black
5	Analogue Output	Green
6	Chassis Ground	cable screen

Dual Frequency Echosounder Configuration

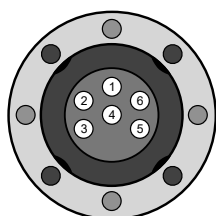

Tritech Waterblock

Pin	Function	Wire colour
1	RS232 Tx/RS485A	Yellow
2	RS232 Rx/RS485B	Blue
3	+V DC	Red
4	0V, RS232 GND, AHRS ground	Black
5	AHRS RS232 free running output	Green
6	Chassis Ground	cable screen



Note

The Dual Frequency Echosounder does not have an analogue output. This function is used for the AHRS output.



Note

The AHRS output on pin 5 is **RS232 ONLY**

3.6. Example Test Cables

RS232 Test Cable

EXAMPLE RS232 TEST CABLE

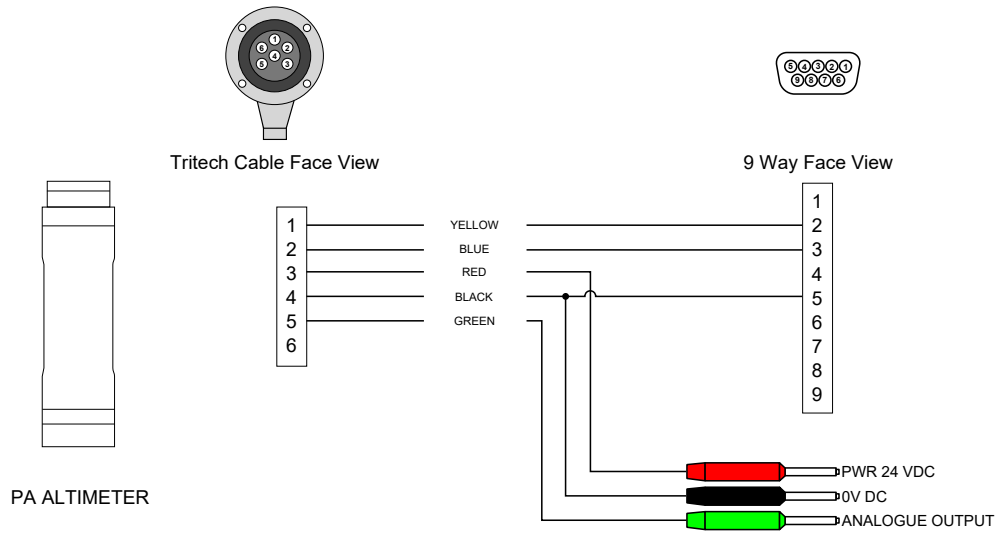

Wiring shown is suitable for a direct connection for a PA Altimeter to a Trittech SeaHub

RS485 Test Cable

EXAMPLE RS485 TEST CABLE

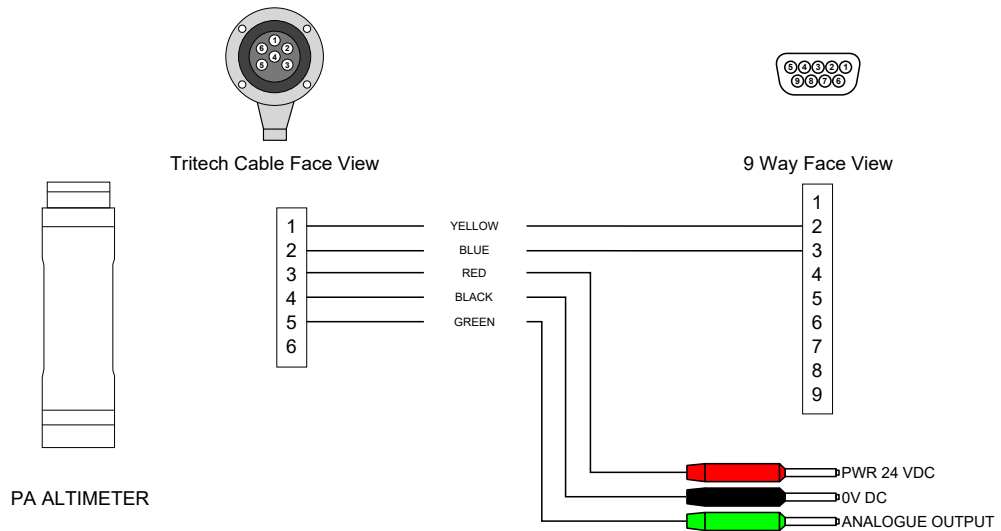

Wiring shown is suitable for a direct connection for a PA Altimeter to a Trittech SeaHub

The above cables test cables can be ordered direct from *Trittech International Ltd* in various lengths using the part numbers below:

S12118 XX –Right Angle Trittech Connector, XX metres

S12119 XX –Straight Trittech Connector, XX metres

Current Loop Test Cable

EXAMPLE CURRENT LOOP TEST CABLE

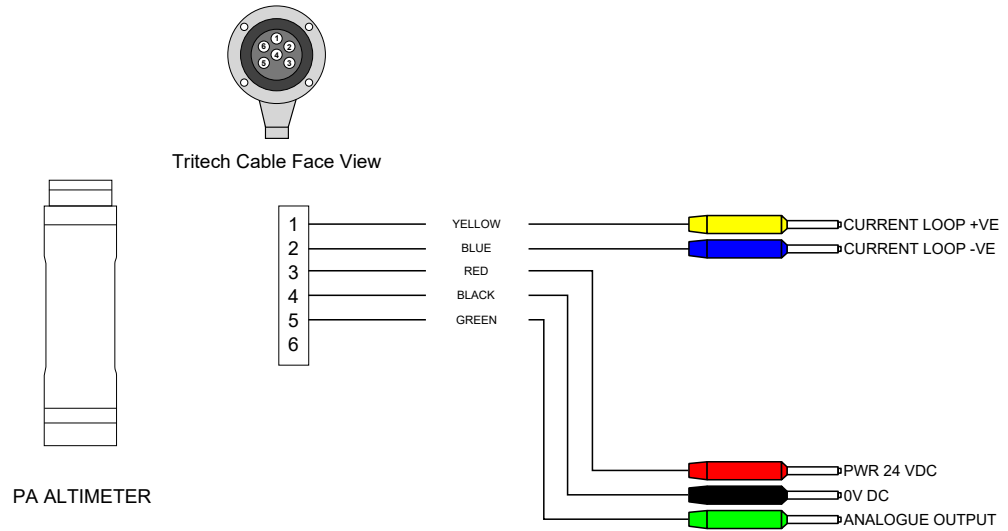

Current Loop Altimeters are not loop powered. The output current is separate from the power supply.

4. Operation

4.1. General Guidelines



Notes

The output from the altimeter can be in serial or analogue format. This section only covers applications which use the data in serial format.

Altimeters configured with a 10m range may give false readings (neither zero or max range) when operating in air.

Output Strings

The serial output is either interrogated (i.e., the software asks for a response) or is free-running and will continuously send out acoustic pulses and supply the output from the altimeter to the connected computer even if the software is not running.

The output is an ASCII data string terminated with a carriage return and line feed (<CR><LF>) and will be in one of three formats depending on the hardware settings. These formats are as follows:

2P3

```
xx . xxxm<CR><LF>
```

xx . xxx = range in metres to 3 decimal places

m = units label for metres

<CR><LF> = carriage return and line feed terminators.

3P2

```
xxx . xxm<CR><LF>
```

xxx . xx = range in metres to 2 decimal places

m = units label for metres

<CR><LF> = carriage return and line feed terminators.

3P3

```
xxx . xxxm<CR><LF>
```

xxx . xxx = range in metres to 3 decimal places

m = units label for metres

<CR><LF> = carriage return and line feed terminators.

NMEA \$DBT

```
$PADBT, xxx . xx, f, yyy, yy, M, zzz . zz, F*hh<CR><LF>
```

xxx . xx is the range in feet

yyy . yy is the range in metres

zzz . zz is the range in fathoms

hh is an 8-bit checksum

<CR><LF> = carriage return and line feed terminators.

In free running mode the unit will start to output data immediately upon power up (the data rate is about 10Hz for a PA500 or 7Hz for a PA200). If the altimeter has been set to interrogate mode it will not output data until the interrogate command (Z) is received, at which point a single data string is transmitted to the surface computer.



In RS232 mode

When operating an RS232 altimeter it is possible to change the mode of operation from free running to interrogate and back. Sending an F character will change the unit to operate in free running mode and sending a Z character will change it to operate in interrogate mode.



In RS485 mode

For RS485 units the mode should not be changed via serial commands. The RS485 protocol used is a 2 wire half duplex and this means that the unit never enters the 'listen' mode when set to free running so attempting to change the unit with a serial command may result in unforeseeable results or loss of communication with the device.

To confirm which mode the altimeter is in a simple test is to power on the unit and listen for any audible clicks or pings. In free running mode the altimeter will start pinging as soon as it receives power but in interrogated mode it should remain silent.



Warning

NEVER place the transducer close to the ear to listen for the clicks. Doing so could result in permanent damage to the eardrum. Always remain at least 15cm away from the transducer.

Data Stream Characteristics

The default altimeter output communication characteristics are as follows:

- 9600 baud
- 8 data bits
- 1 stop bit
- No parity
- No flow control

Depending on the dip switch settings the unit will either output a 0 result or the maximum possible result whenever a valid signal is not detected (i.e., fail low or fail high). These settings are, respectively, Zero No Echo (ZNE) or Max No Echo (MNE). These settings are fully hardware controlled and cannot be over-ridden in software.

4.2. Dual Frequency Echosounder

The Dual Frequency Echosounder contains two altimeters and an AHRS sensor. This allows it to output both an altitude and attitude. The altitude readings are interrogate only whereas the attitude can be either interrogate or free-running.

4.2.1. Echosounder Output

The Dual Frequency Echosounder does not have a free running altitude output. The 500kHz or 200kHz channel must be interrogated individually.

The 200kHz channel is interrogated using the ASCII character **A**

The 500kHz channel is interrogated using the ASCII character **B**

The output from the echosounder is as follows:

LAN Interrogate

```
Yxxx . xxxm<CR><LF>
```

Y = ASCII interrogation character, A for 200kHz, B for 500kHz

xxx . xxx = range in metres to 3 decimal places

m = units label for metres

<CR><LF> = carriage return and line feed terminators.

4.2.2. AHRS Output

Tritech Pin 1 & 2

The AHRS can be set to output in interrogate mode similar to the echosounder output. In interrogate mode the free running output on pin 5 stops and then the AHRS is interrogated with the ASCII character **C**.

Tritech Pin 5

The main output from the AHRS on the Dual Frequency Echosounder is on pin 5 of the Tritech connector. In this configuration output the AHRS output is free running.



Note

The output from pin 5 is RS232 Tx only

Industry Standard Output Strings

NMEA HDT

```
$--HDT,x.x,T*hh<CR><LF>
```

NMEA TRO

```
$--TRO,x.xx,a,y.yy,b*kk<CR><LF>
```

NMEA TRH

```
$--TRH,x.xx,a,y.yy,b,z.zz,c*kk<CR><LF>
```

PASHR

```
$PASHR,hhmmss.sss,HHH.HH,T,±RRR.RR,±PPP.PP,,rr.rrr,pp.ppp,hh.hhh,x,x*kk<CR><LF>
```

TSS1

```
XXAAAASMHHHHQMRRRRSMPPPP<CR><LF>
```

TSS2

```
XXAAAASMHHHHQ MRRRRSMPPPP<CR><LF>
```

4.3. Seanet Pro & SeaKing or Super SeaPrince DST AUX Port

General Guidelines

It is possible to configure the AUX port on a SeaKing or Super SeaPrince DST sonar for input of RS232 or RS485 serial data from a free running altimeter. The altimeter is connected via a dual 6-pin Trittech interconnect cable which has a one-to-one wiring between the pins. The DC power input of the sonar is linked through to the AUX port for the 24V DC supply to the altimeter.



Caution

The supply to the SeaKing head SHOULD NOT exceed 28V DC, doing so will damage the altimeter connected to the AUX port.



Caution

If using an altimeter with the RS232 board fitted it will be necessary to modify the SeaKing head to enable communication. Details for this procedure can be found in Appendix A, *Jumper Settings for SeaKing with Altimeter on AUX Port*. For this reason it is recommended that an altimeter is chosen with the RS485 board fitted because this avoids breaking the power isolation in the SeaKing head and also allows the altimeter analogue output to be passed through the sonar head (via a jumper setting within the SeaKing and on Pin 5).



Note

The altimeter will have to be in a compatible free running mode in order to work. If it is set up for interrogated mode the switch settings will have to be changed

within the unit, refer to Chapter 6, *Configuration* for more details of the correct dip switch settings and supported modes.

Configuring Seanet Pro

First launch the `Seanet Setup` application and ensure that *Node 2* is detected in the table, indicating that the SeaKing sonar head is visible to the computer. Click the `Action` column for Node 2 and then select `Setup`.

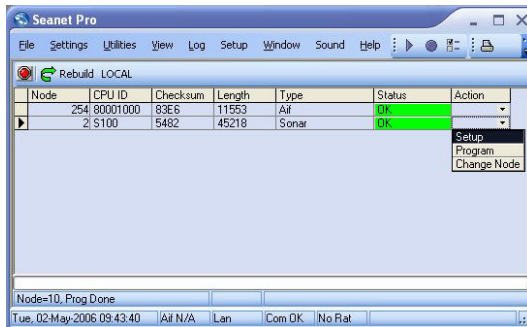

In the sonar setup dialog which is presented, ensure that the `Has Aux or Compass` check box is enabled.

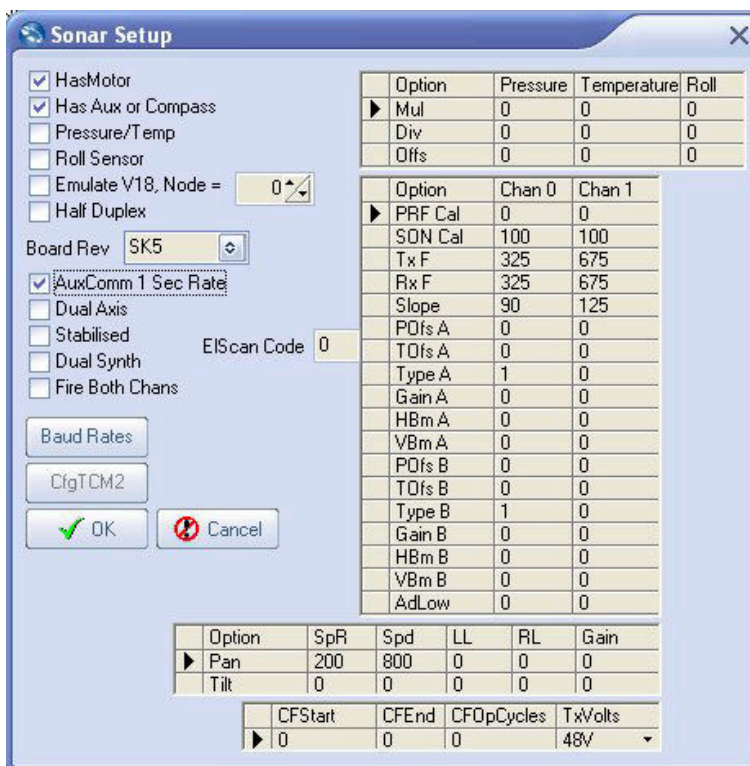

Note

If the sonar is a V6 DST Super SeaKing or Super SeaPrince DST then the AUX port is enabled continuously. A V6 can be identified by having a different setup screen as shown below. For the Super SeaPrince DST the `Comms Mode` selection is used to control the AUX port as well as the MAIN port so the protocol and baud rates for the AUX port will need to be set correctly.

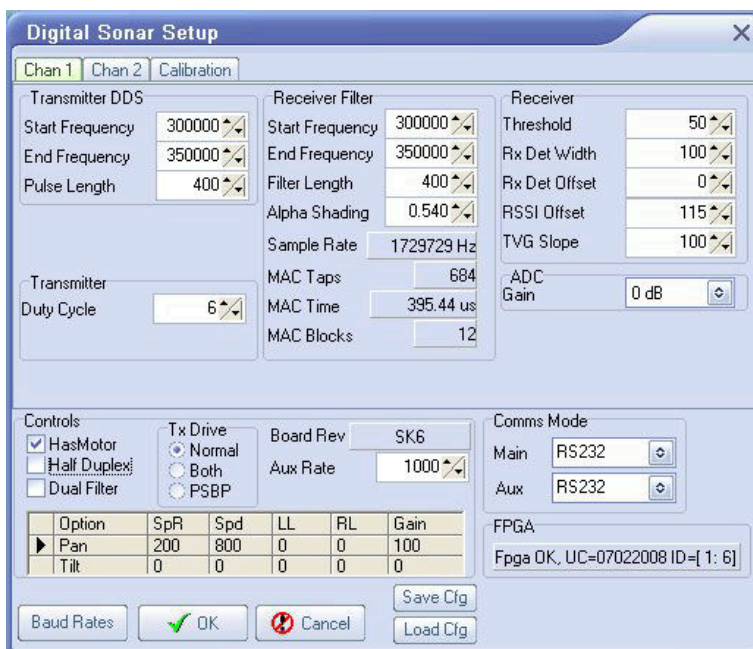

Note

If the AuxComm 1 Sec Rate check box is disabled, the sonar will try to send all of its data and the data collected through the auxiliary port in one go. If the quantity and rate of this data is too great then the interface may hang.

From the above dialog click on the Baud rates button and check that the rates on the Async 1 (AUX) match the device output (this is normally 9600 baud for altimeters).

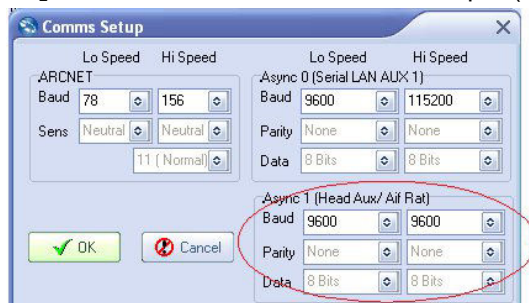

Configuring the SeaKing Head

After the software has been configured the SeaKing head should be modified to allow correct communication.

For the correct jumper settings refer to Appendix A, *Jumper Settings for SeaKing with Altimeter on AUX Port*



Important

In order to change the jumper settings it will be necessary to expose sensitive electronics within the SeaKing head and so appropriate measures should be taken to protect against the possibility of static discharge which may damage the sonar head.

Seanet Pro Display

Once the sonar head has been correctly configured with the altimeter connected, power up the system and run the main Seanet Pro application. Test the operation of the system by running a *Sonar Application* which should display similar to the screenshot below. Note that the altimeter data received via the sonar AUX port is displayed as a reading in metres on the *Sonar Settings Bar*.



Note

The altimeter data will be logged along with the sonar data and will be displayed during later playback of the log file.

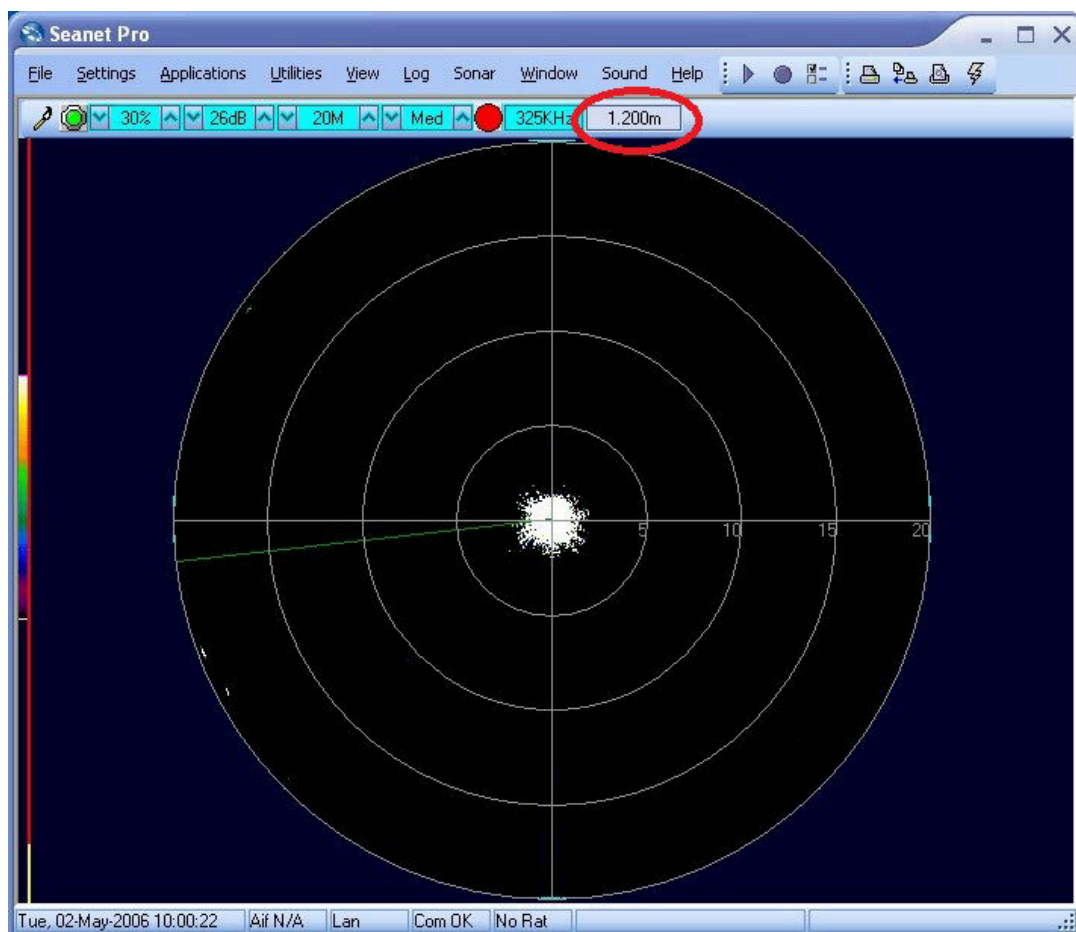

Regional Settings and AUX Data

Under certain versions of Windows the regional settings can prevent the flow of data from an AUX port through the system. If the device has been connected correctly and is operating properly but no data is displayed on the screen then the regional settings may be preventing Seanet Pro from processing the data.

This problem can be overcome using two methods:

1. From the Windows Control Panel open *Regional & Language Options* and set the drop down list to *English (United Kingdom)* and press *OK* for the changes to take effect. It will be necessary to restart the Seanet Pro application after this change has been made.

- If it is desired to continue using the existing regional settings then from the *Regional & Language Options* dialog find the existing language settings and choose *Customise*. Locate the setting for *Decimal Symbol* and make sure it is set to "."

4.4. Using with SeaKing 700 Series (Bathy)

Usually if using an altimeter with a SeaKing 700 Series device it is merely a case of connecting the altimeter supplied as part of the system to the AUX port. If another altimeter is to be used it will have to be configured using the dip switches (see Chapter 6, *Configuration*) to work correctly.

A comprehensive description of the correct setup for the SeaKing 700 Series can be found in the SeaKing 700 Series Product Manual.

4.5. AltTest Software

General Guidelines

The AltTest program available from Tritech provides a simple way of communication with Tritech altimeters and displaying the data. It is compatible with Microsoft Windows. Altimeter data can be logged in a raw or processed format and the processed data can be imported into a spreadsheet package for post-processing.



Note

AltTest is freely available from www.tritech.co.uk

The main display for the AltTest program is as follows:

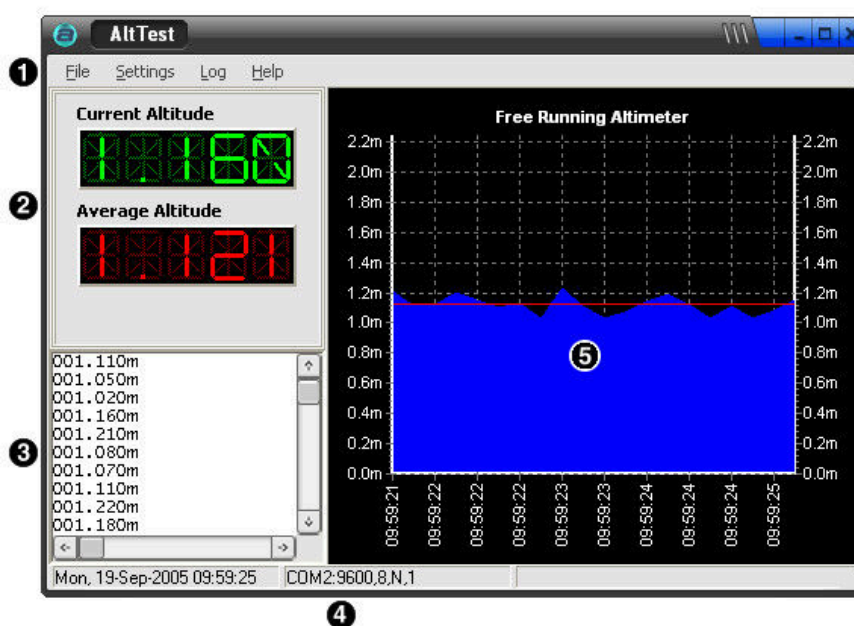

- Menu Options.

2. Current and average altitude display. The display will change depending on the operating mode.
3. Terminal style window displaying the raw data received from the altimeter.
4. Serial port settings.
5. Scrolling altitude chart. Displays current altitude in solid blue and average altitude as a red line.

Menu Functions

- | | |
|----------|---|
| File | <code>Exit</code> closes the AltTest application. |
| Settings | <ul style="list-style-type: none"> • <code>COM port</code> to change the settings of the COM port. • <code>Options</code> to change the application options (see below). |
| Log | <ul style="list-style-type: none"> • <code>Format</code> selecting a <code>Raw</code> format will log the exact data string that is sent by the altimeter while <code>Processed</code> will log all the processed data and settings in Comma Separated Value (CSV) format. • <code>Setup</code> sets the logging options (see below). • <code>Record</code> toggle to start/stop logging the data. |
| Help | <code>About</code> details the AltTest application, while <code>System</code> shows information about the Windows system. |

Options and Log Setup Dialogs

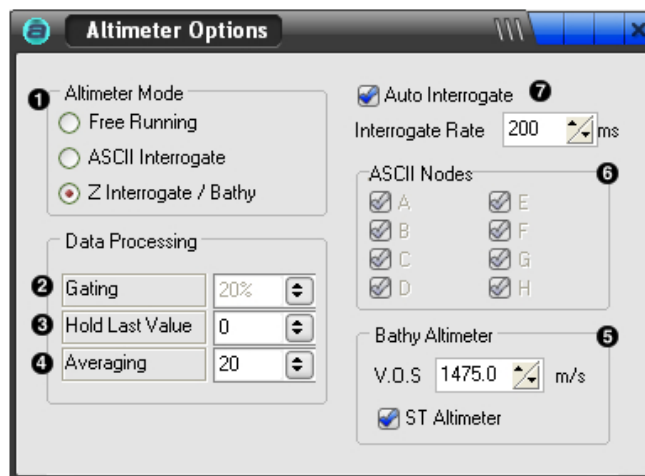

1. `Altimeter Mode` sets the operating mode (see descriptions below).
2. `Gating` to select the percentage to user for the gating range of an altitude reading. The gating range is calculated as \pm the gating of the last altitude reading (i.e., for gate set at 20% the gating range is $\pm 20\%$ of the last altitude reading). If the next altitude reading falls out of the range then it is regarded as invalid and the previous altitude reading is used.
3. `Hold Last Value` for selecting how long the program will hold onto the last valid altitude reading. If an altitude reading falls out of the gating range of the previous reading then it

will be held for a specified number of readings or until a reading within the gating range is received. If this is set to "0" then AltTest ignores gating ranges and regards all altitude readings as valid.

4. **Averaging** for selecting how many data samples to use when calculating the average altitude of an altimeter.
5. **Bathymetric Options** for entering the velocity of sound when AltTest is used with a Bathymetric altimeter. Also allows the selection of older "ST" model altimeters.
6. **ASCII Nodes** for selecting the ASCII Addressed Nodes to be interrogated. Only available in ASCII Interrogate Mode.
7. **Auto Interrogate** set to automatically interrogate the altimeter by the interval set. Only available in ASCII Interrogate or Z Interrogate modes.

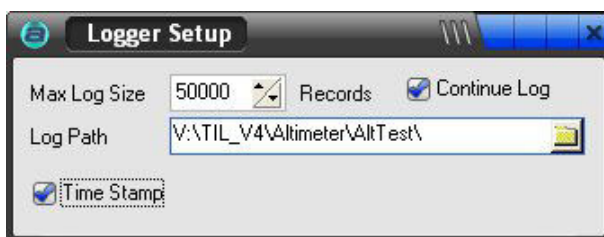

- | | |
|--------------|--|
| Max Log Size | Set the maximum number of records a log file can hold. |
| Log Path | Set the path to store the log files. |
| Time Stamp | Check to time stamp each line of log data. |
| Continue Log | Check to continue logging to a new file once the maximum number of log records has been reached. |

Free Running Mode

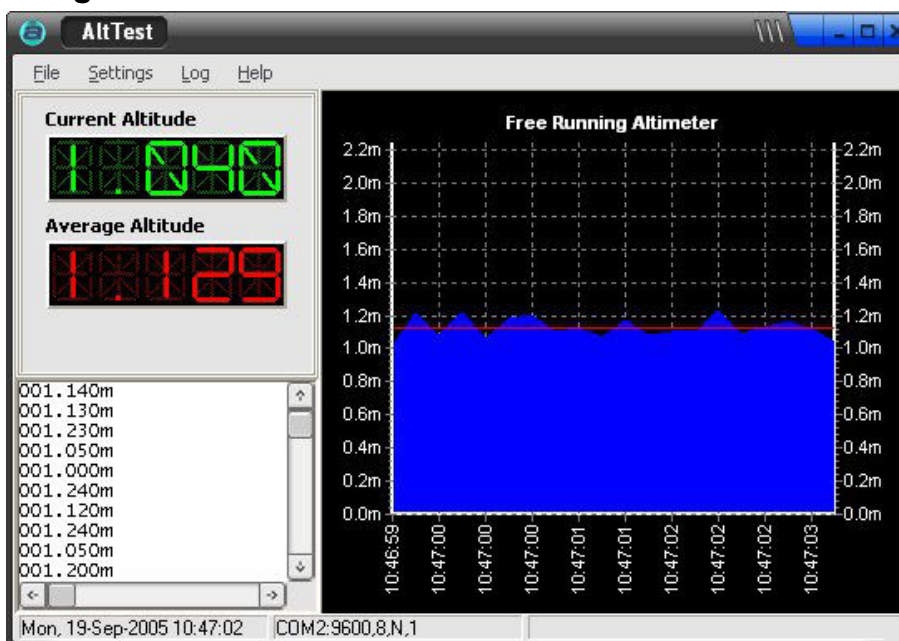

Select Free Running Mode for an altimeter which has been configured to operate as a free running altimeter. The altimeter mode is set by dip switches (see Chapter 6, *Configuration*).

When in free running mode, the altimeter is operating under its own control sending out data and it requires no interrogation from the AltTest program.

AltTest displays the current altitude of the altimeter and plots it on the chart. AltTest will also calculate an average altitude using the specified number of data samples set from the *Options* dialog and this is also displayed on the chart. The number of data samples displayed on the chart will be the same number used to calculate the average altitude.

ASCII Interrogate Mode

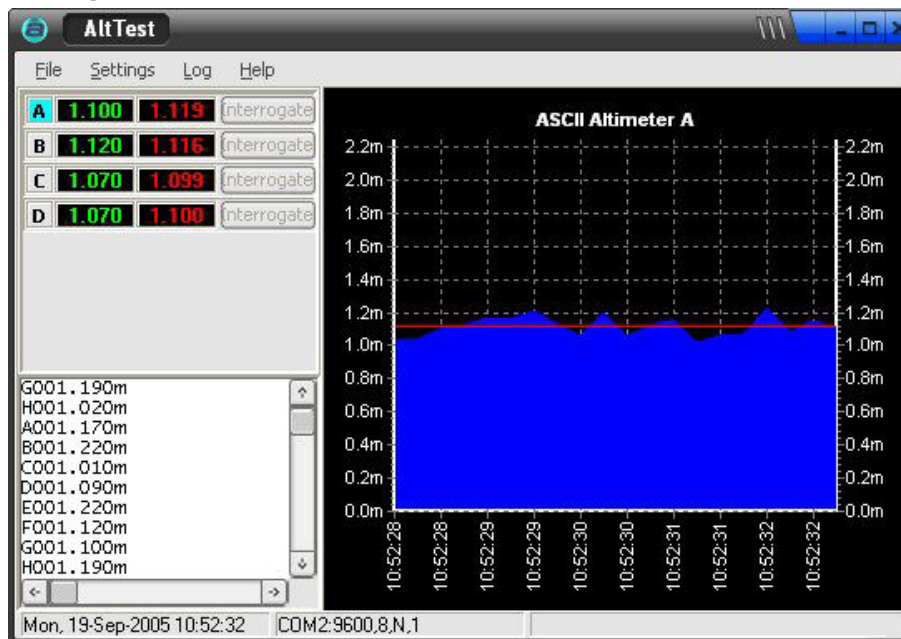

Select ASCII Interrogate Mode for altimeters configured as ASCII addressable nodes (single character ASCII address in the range A to H). The address is set by switch settings inside the altimeter (see Chapter 6, *Configuration*) and are always triggered by interrogation (they cannot free run).

ASCII addressable units may be connected together on an RS485 or multidrop RS232 communications link.

AltTest allows the user to select which addressable units are available for interrogation. Nodes that have been selected are on the display. Each node can be manually interrogated by pressing its *Interrogate* button. All available nodes can also be automatically interrogated using the *Auto Interrogate* function at the rate defined from the *Options* dialog.

AltTest displays the current altitude of the altimeter. It also calculates an average altitude using a specified number of data samples which is also displayed. The altimeter data displayed on the chart can be selected by clicking on an altimeter's address panel which will then be highlighted. The number of data samples plotted on the chart will be the same number used to calculate the average altitude.

Z Interrogate (Bathymetric) Mode

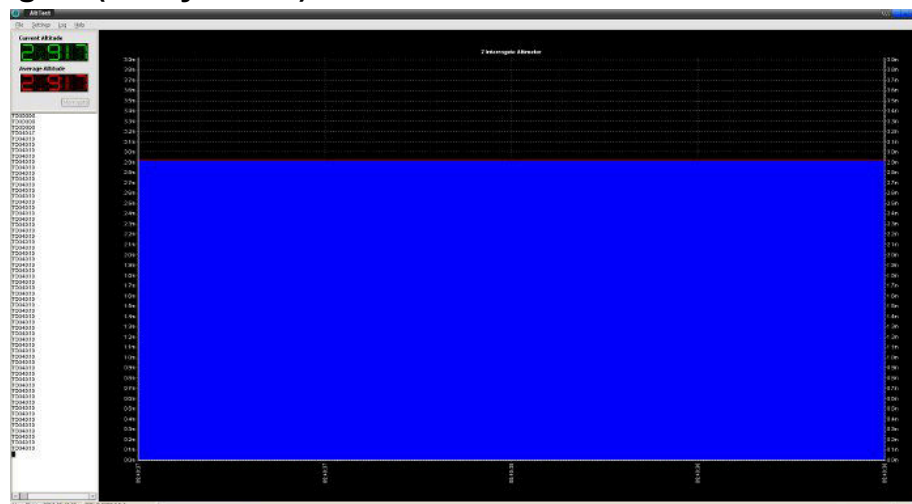

Select Z Interrogate mode for an altimeter configured to be interrogated by the character "Z" or for an altimeter configured to be used as part of a SeaKing Bathymetric system.

AltTest allows the user to manually interrogate the altimeter by pressing the `Interrogate` button. The altimeter can also be automatically interrogated using the `Auto Interrogate` function at the rate defined by the settings in the `Option` dialog.

AltTest displays the current altitude of the altimeter and plots it on the chart. AltTest will also calculate an average altitude using a specified number of data samples which is also displayed and charted. The number of data samples plotted on the chart will be the same number used to calculate the average altitude.

Regional Settings and AltTest

Under certain versions of Windows the regional settings can prevent the flow of data from the serial port to AltTest. If the device has been connected correctly and is operating properly but no data is displayed on the screen then the regional settings may be preventing AltTest from processing the data.

This problem can be overcome using two methods:

1. From the Windows Control Panel open `Regional & Language Options` and set the drop down list to `English (United Kingdom)` and press `OK` for the changes to take effect. It will be necessary to restart the `Seanet Pro` application after this change has been made.
2. If it is desired to continue using the existing regional settings then from the `Regional & Language Options` dialog find the existing language settings and choose `Customise`. Locate the setting for `Decimal Symbol` and make sure it is set to "."

5. Maintenance

5.1. General Guidelines



Note

Every time the altimeter is retrieved from the water it should be washed with a mild soap solution to clear any marine growth and inspected for signs of damage.

The standard altimeter has three user serviceable items:

- The o-ring on the transducer endcap.
- The o-ring on the connector endcap.
- The o-ring present underneath the waterblock.



Note

Alternative configurations may have additional serviceable items, if in doubt please contact *Tritech International Ltd* to establish the correct service routine.

The o-ring seals should be regularly inspected, cleaned and lubricated with the appropriate greasing compound. The body of the unit should also be inspected for any obvious signs of corrosion, especially in mating surfaces (such as the waterblock).



Caution

It is essential to have a regular maintenance schedule so that any defects arising from corrosion or erosion can be spotted early and corrected before they cause severe damage to the unit.



Caution

Care should be taken when inspecting the altimeter with a delrin housing material due to the internal copper earth shield. This shield can be easily damaged by the PCB during disassembly and subsequent re-assembly.

5.2. Ordering Parts

For replacement parts or spare parts it will be necessary to correctly identify the altimeter in use. Since there are a vast amount of different configurations of altimeters the simplest way to do this is to contact *Tritech International Ltd* providing the serial numbers off the unit body.

Serial numbers are either located on the silver label affixed to the body tube or if this has been damaged the embossed numbers on the transducer endcap, body tube and connector endcap can be used instead.

5.3. Disassembly of the Altimeter



Important

The steps outlined here will expose sensitive electronic equipment and so appropriate steps should be taken to prevent any static discharge occurring which may harm the equipment.

Service tools required

- Clean absorbent wipes
- Silicon grease MS-111 lubricant (or equivalent)

Disassembly

1. First rinse the altimeter and connector in fresh water and dry with absorbent wipes.
2. Grasp the connector endcap firmly in one hand and the body tube in the other.
3. Gently unscrew the body tube.
4. The electronics block will then slide out of the housing attached to the connector endcap.
5. The transducer may be unscrewed from the opposite end of the body tube in the same way.

Re-assembly

1. Carefully clean all parts and check for damage.
2. Inspect o-ring seals and replace if necessary.
3. Check that the earth loop on the electronics block is secure and sprung so that it will contact the inside face of the body tube when it is fitted.
4. Lightly grease the o-rings, o-ring grooves and mating surfaces.
5. First screw on the transducer to the body tube until the thread shoulder faces contact.
6. Carefully insert the electronics block into the body tube and screw on the connector endcap.
7. Ensure that the individual parts are aligned and mating correctly.



Caution

The threads of the altimeter should be made up and broken out by hand, or by using light pressure on a strap wrench. The application of additional force may indicate and result in damage to the unit.

6. Configuration

6.1. Non-configurable Parts

Normally when an altimeter is ordered from *Tritech International Ltd* a configuration sheet is filled out with the customer to specify the function of the device exactly. Some of these configurations are controlled through dip switches (detailed below), however, the following list of parts are determined by a particular hardware configuration.



Note

It is possible to replace or alter some of these components, however, doing so would normally require the altimeter to be returned to *Tritech International Ltd* for a re-build. Contact details are at the start of this manual if such a change is desired.

The following aspects are usually fixed at manufacture for the life of the product:

Physical hardware	Casing, connector type and wiring scheme.
Analogue Voltage Control	Fixed at: none, 5V or 10V - altering this would require a new electronics block.
Serial/Current output	Fixed at: 4-20mA, RS232 or RS485 - altering this would require a new communications board.
Ping rate	The default ping rate for free-running mode is approximately 10Hz for a PA500 and 7Hz for a PA200 (other ping rates are available).
Velocity of Sound	Set to either 1470m·s ⁻¹ or 1473m·s ⁻¹

6.2. Dip Switch Settings



Note

The switch positions shown here are the generic settings which apply to all altimeters. There are other combinations which relate to specific customer's requirements and these are not shown. If in doubt contact *Tritech International Ltd* prior to making any changes.

SW1 Dip Switches							Input/Output			
ID	1	2	3	4	5	6	String Output Format	Output Behaviour	Output if no echo received	Interrogate Character
4	0	0	1	0	0	0	000.000m	Interrogated	Zero	Z
5	1	0	1	0	0	0	000.000m	Free Running	Zero	n/a
6	0	1	1	0	0	0	000.000m	Interrogated	Maximum	Z
7	1	1	1	0	0	0	000.000m	Free Running	Maximum	n/a
8	0	0	0	1	0	0	00.000m	Interrogated	Zero	Z
9	1	0	0	1	0	0	00.000m	Free Running	Zero	n/a
10	0	1	0	1	0	0	00.000m	Interrogated	Maximum	Z
11	1	1	0	1	0	0	00.000m	Free Running	Maximum	n/a
12	0	0	1	1	0	0	000.00m	Interrogated	Zero	Z
13	1	0	1	1	0	0	000.00m	Free Running	Zero	n/a
14	0	1	1	1	0	0	000.00m	Interrogated	Maximum	Z
15	1	1	1	1	0	0	000.00m	Free Running	Maximum	n/a
16	0	0	0	0	1	0	Bathymetric	Interrogated	Zero	Z
17	1	0	0	0	1	0	NMEA	Free Running	Zero	n/a
18	0	1	0	0	1	0	NMEA	Free Running	Maximum	n/a
32	0	0	0	0	0	1	A000.000m	Interrogated	Zero	A
33	1	0	0	0	0	1	B000.000m	Interrogated	Zero	B
34	0	1	0	0	0	1	C000.000m	Interrogated	Zero	C
35	1	1	0	0	0	1	D000.000m	Interrogated	Zero	D
36	0	0	1	0	0	1	E000.000m	Interrogated	Zero	E
37	1	0	1	0	0	1	F000.000m	Interrogated	Zero	F
38	0	1	1	0	0	1	G000.000m	Interrogated	Zero	G
39	1	1	1	0	0	1	H000.000m	Interrogated	Zero	H
40	0	0	0	1	0	1	A000.000m	Interrogated	Maximum	A
41	1	0	0	1	0	1	B000.000m	Interrogated	Maximum	B
42	0	1	0	1	0	1	C000.000m	Interrogated	Maximum	C
43	1	1	0	1	0	1	D000.000m	Interrogated	Maximum	D
44	0	0	1	1	0	1	E000.000m	Interrogated	Maximum	E
45	1	0	1	1	0	1	F000.000m	Interrogated	Maximum	F
46	0	1	1	1	0	1	G000.000m	Interrogated	Maximum	G
47	1	1	1	1	0	1	H000.000m	Interrogated	Maximum	H



Note

On SW1 settings with ID0 to ID3 are for factory use only. ID19 to ID31 and greater than ID47 relate to application specific configurations. If the altimeter has a switch setting that is not listed, please contact Trittech prior to making any changes.

SW2 Dip Switch			
2	3	4	Analogue Scaling
1	1	1	2m
0	1	1	5m
1	0	1	10m
0	0	1	15m
1	1	0	20m
0	1	0	30m
1	0	0	50m
0	0	0	100m

**Note**

On SW2 dip switch 1, 5 and 6 are for factory use only and should not be changed without direct instruction from Trittech.

Appendix A. Jumper Settings for SeaKing with Altimeter on AUX Port



Note

If the sonar is fitted with a COMV6 PCB it will not be possible to change the settings using jumper switches and instead the settings should be changed through software using the *Seanet Setup* program.

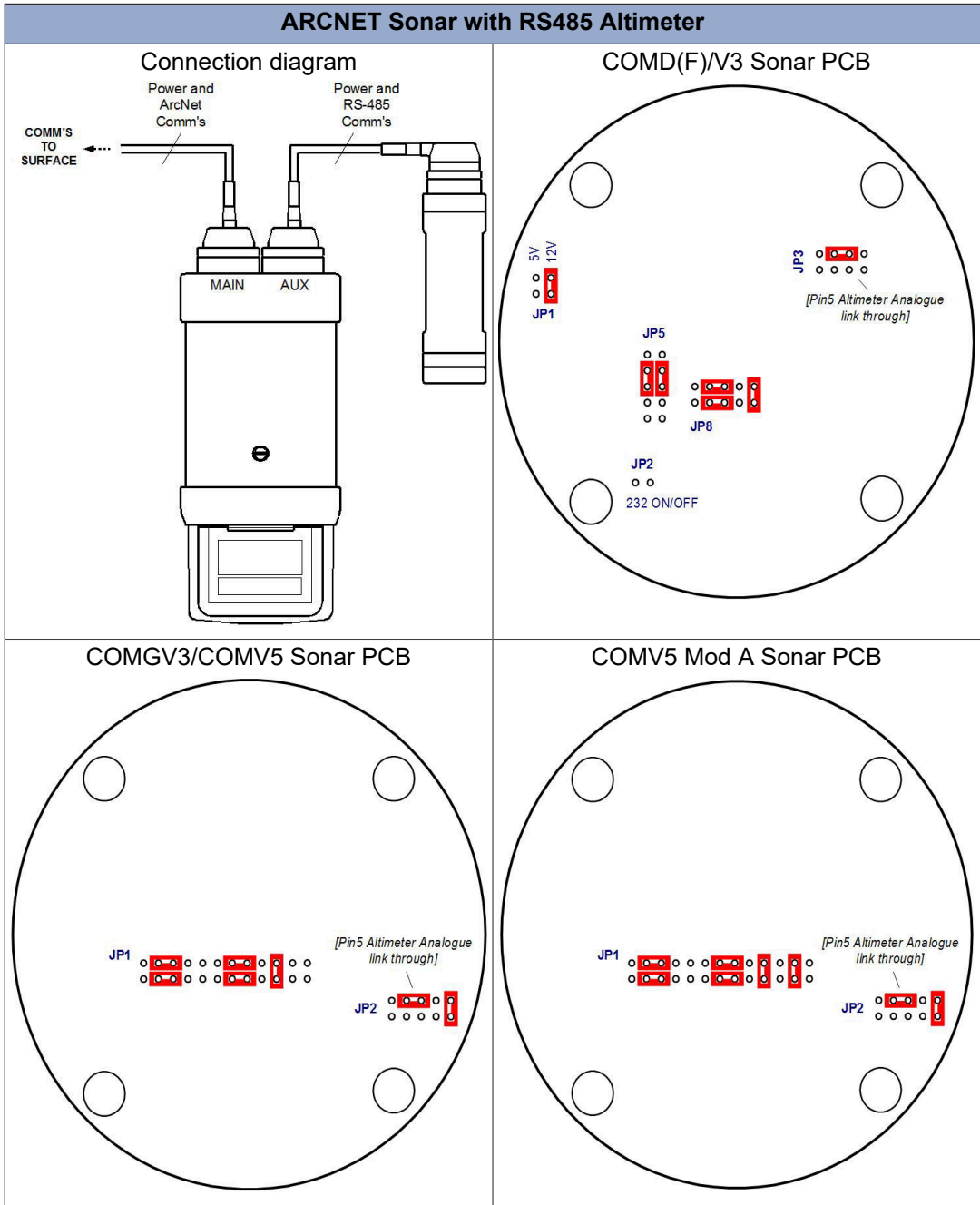

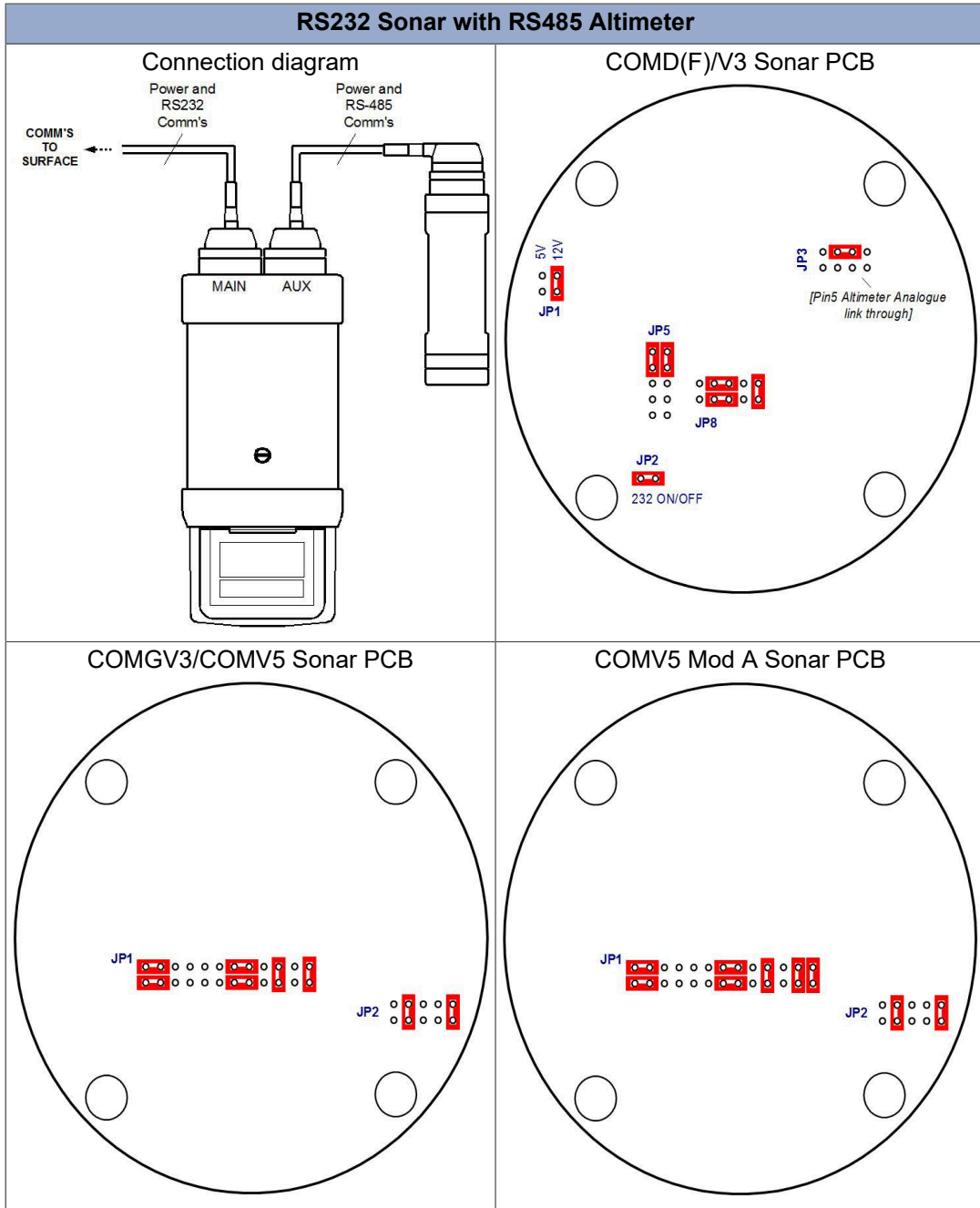

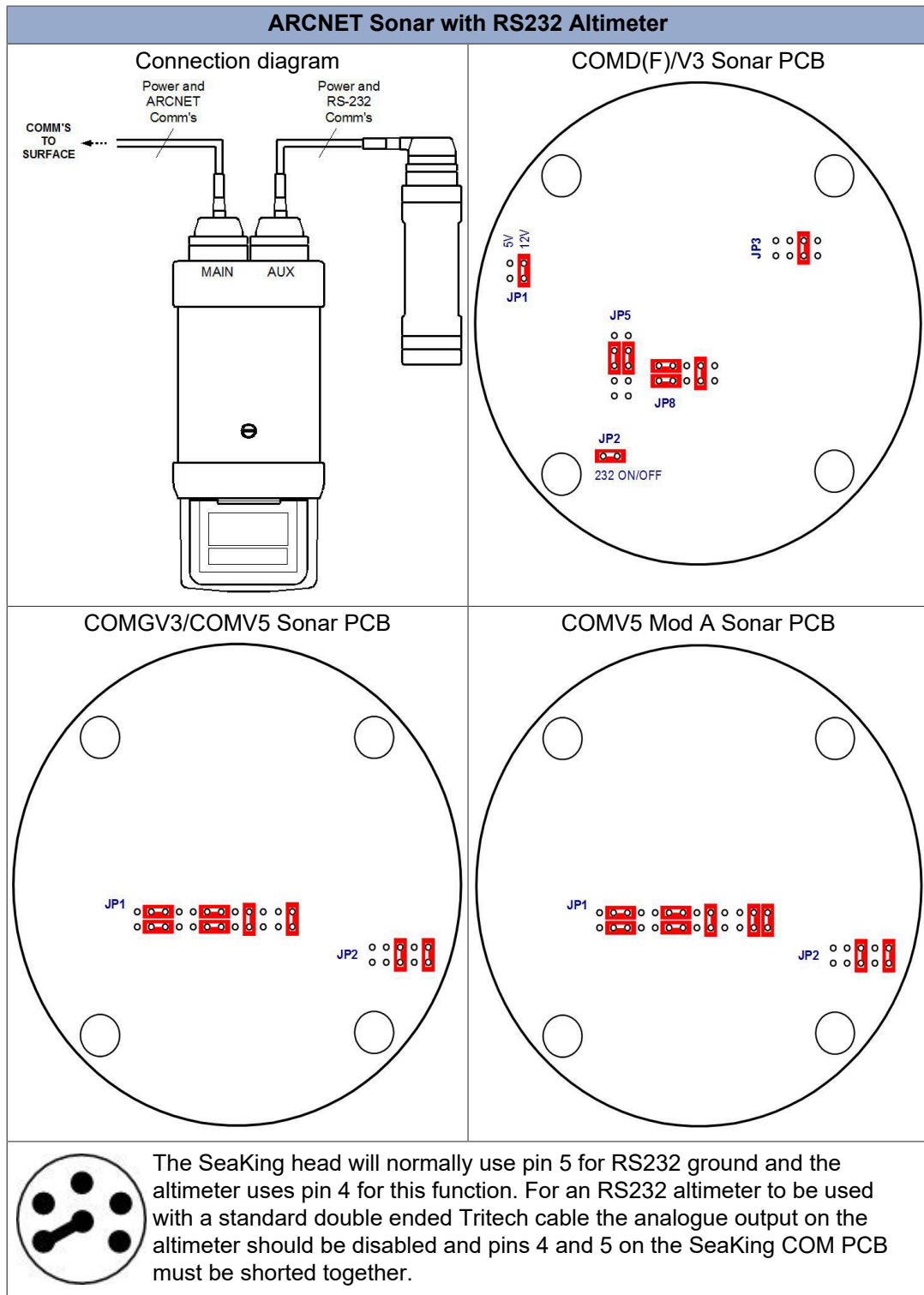

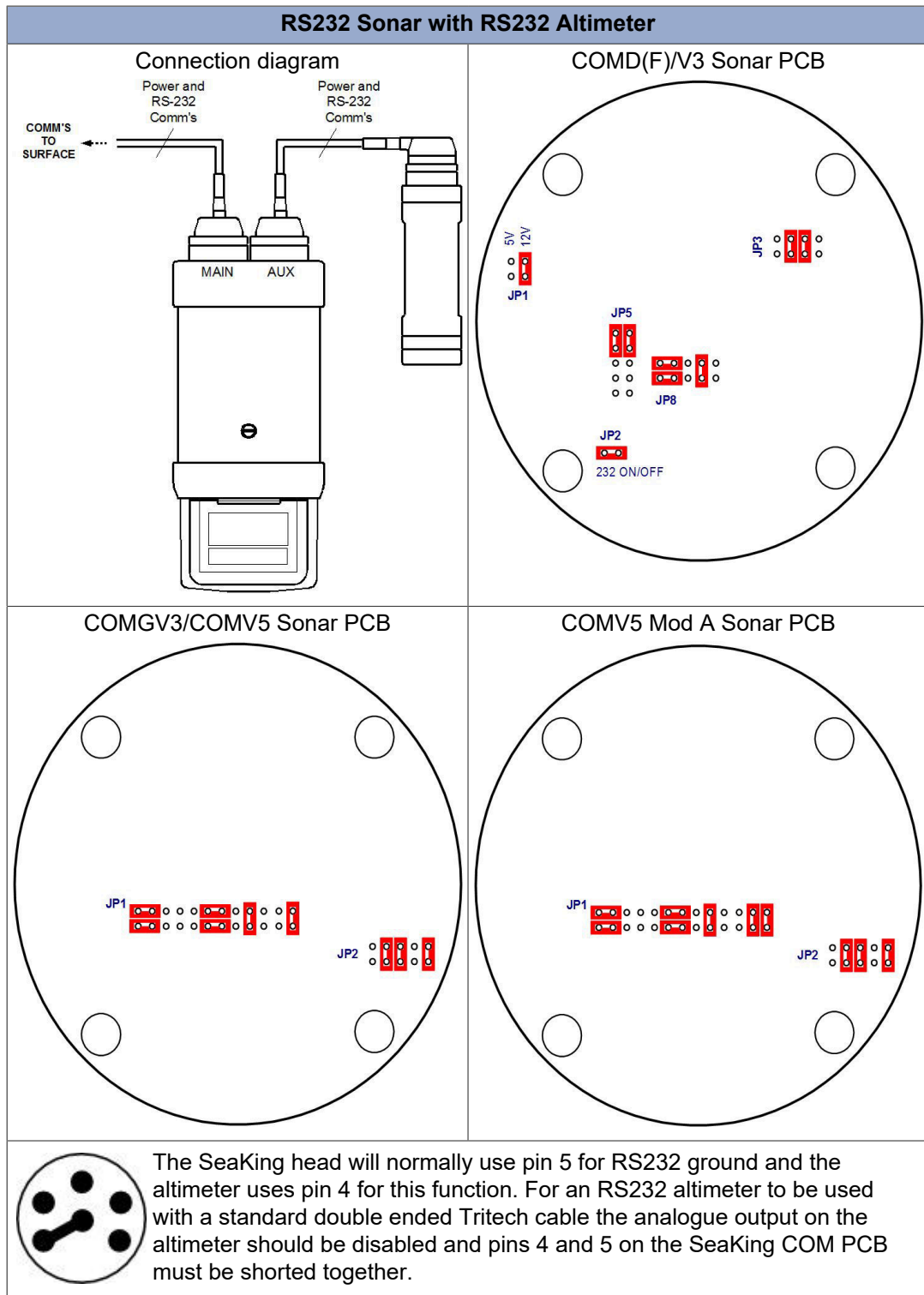

Appendix B. Addressable Altimeter

The Tritech PA Altimeter may be set up addressable using a single character ASCII address in the range A to H.

The ASCII address is set by switch settings inside the Altimeter. When a unit is set as an ASCII addressable unit there are less formatting options available than on a standard Altimeter. The Altimeters are then always triggered by interrogation (they cannot free run).

The Altimeter is interrogated by an ASCII address character (e.g. A), or by the * character which will trigger all addresses. On receipt of the trigger character the Altimeter sends its acoustic transmit pulse immediately, after the timeout range associated with the range setting, plus an additional delay as an increment of 26msec dependent on the address, the Altimeter then sends an ASCII reply.

The following table shows the reply times in msec for the different addresses.

	A	B	C	D	E	F	G	H
10m range	18	44	70	96	122	148	174	200
50m range	72	98	124	150	176	202	228	254
100m range	140	166	192	218	244	270	296	322

The reply message is constructed as follows :

LAN Interrogate

```
Yxxx . xxxm<CR><LF>
```

Y = ASCII interrogation character A-H

xxx . xxx = range in metres to 3 decimal places

m = units label for metres

<CR><LF> = carriage return and line feed terminators.

The interface uses 9600 bits/s, 8 data, no parity and 1 stop bit for both the interrogate character and the reply. Each reply string lasts about 13msec.

Altimeters may be configured for multidrop RS232 or RS485 communications. When using the * (asterix) character to trigger a collection of Altimeters, each one must have a different address. Whilst waiting for all the expected replies to be received, only **one** * character should be sent.

See below an example timing diagram for four Altimeters (A,B,D,E) set for 10m range in response to * interrogate.

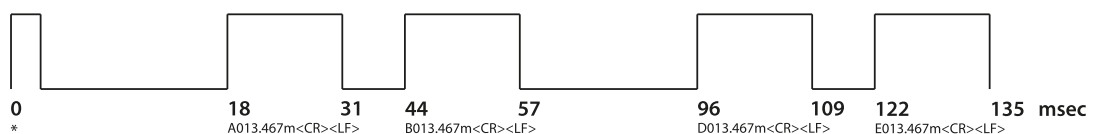

Note

Changing the ASCII address requires opening the Altimeter. Internally there are two banks of 6 miniature switches inside labelled SW1 and SW2.

For the dip switch setting see ID numbers 32 -47 in Chapter 6, *Configuration*

**Note**

For disassembly of the unit see Section 5.3, “Disassembly of the Altimeter” or contact *Tritech International Ltd* for advice.

Glossary

ABS	Acrylonitrile Butadiene Styrene - a common thermoplastic.
AHRS	An Attitude and Heading Reference System that consists of a sensors on three axes that provide attitude information.
ARCNET	Attached Resource Computer NETwork - a network protocol similar to Ethernet but with the advantage of working over much longer ranges.
ASCII	American Standard Code for Information Interchange - a character encoding scheme originally based on the English alphabet.
Bathy	Alternate name for the <i>Tritech International Ltd</i> SeaKing 700 Series Integrated Oceanographic Sensor Suite which outputs data about the conditions of the seawater and water column which may have an affect on the sonar (temperature, depth, etc.,)
CSV	Comma Separated Value - a text file in tabular format with table cells separated by commas, usually given the filename extension <code>.csv</code> but this can vary depending on the application.
DC	Direct Current
DST	Digital Sonar Technology
PA500	An altimeter sold by <i>Tritech International Ltd</i>
PCB	Printed Circuit Board
ROV	Remotely Operated Vehicle
RS232	Traditional name for a series of standards for serial binary data control signals.
RS485	A standard for defining the electrical characteristics of drivers and receivers for use in a balanced digital multipoint system (also known as EIA-485).
SCU	Surface Control Unit - a specially manufactured computer which is rack mountable and capable of processing the data from the sonar equipment running either Windows® XP Embedded or Windows® 7 and Seanet Pro or Gemini software.
SeaHub	An alternative to using a Seanet SCU, this device connects to a laptop or PC via USB interface, essentially this takes the signal from the sonar (in RS232, RS485 or ARCNET) and converts it into a signal suitable for the USB port of the computer.
SeaKing	A specific sonar produced by <i>Tritech International Ltd</i> but also refers to the family of sonar equipment manufactured by <i>Tritech International Ltd</i> comprising of the SeaKing, SeaKing DST scanning and profiling sonars and the Hammerhead survey sonar.
Seanet Pro	The software supplied by <i>Tritech International Ltd</i> which is capable of running all the sonar devices.
SeaPrince	A more compact sonar than the SeaKing which operates at a single fixed frequency

Tritech waterblock The 4000m depth rated connector developed by *Tritech International Ltd* for their subsea equipment.